

IEC Appliance Inlet C14 Modular Assembling Options



Power Entry Module with Appliance Inlet, Appliance Outlet, Fuse Drawer, Line Switch and EMC Filter

Power Entry Module with Appliance Outlet, Fuse Drawer and EMC Filter

Power Entry Module with Appliance Inlet, Appliance Outlet, Line Switch and EMC Filter

Snap-in version

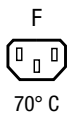

See below:
[Approvals and Compliances](#)

Description

- Panel mount :
 Snap-in version from front side
- 2 - 5 Functions :
 Appliance Inlet Protection class I , Connector , Line Switch 2-pole , Fuseholder for fuse-links 5 x 20 mm 1- or 2-pole , Line filter in standard and medical version
- Solder terminals 3.5 x 0.8 mm or quick connect terminals 6.3 x 0.8 mm

Characteristics

- Modular component selection
- Individual components soldered on a printed circuit board
- Plug removal necessary for fuse-link replacement
- Technical data of filter-components see blockfilter type 5500
- Fully insulated from the rear
- Suitable for use in equipment according to IEC/UL 60950
 Suitable for use in medical equipment according to IEC/UL 60601-1

Other versions on request

- Line switch with other rocker marking

References

Alternative: version without line filter [Felcom 64](#)
 Alternative: Standard version

Weblinks

[pdf data sheet](#), [html datasheet](#), [General Product Information](#), [Distributor-Stock-Check](#), [Accessories](#), [Detailed request for product](#)

Technical Data

Ratings IEC	1 - 10A @ Ta 40 °C / 250VAC; 50Hz
Ratings UL/CSA	1 - 10A @ Ta 40 °C / 250VAC; 60Hz
Leakage Current	standard < 0.5mA (250V / 60Hz) medical < 5 µA (250 V / 60 Hz)
Dielectric Strength	> 1.7kVDC between L-N > 2.7kVDC between L/N-PE Test voltage (2sec)
Allowable Operation Temperature	-25 °C to 85 °C
Climatic Category	25/085/21 acc. to IEC 60068-1
IP-Protection	from front side IP40 acc. to IEC 60529
Protection Class	Suitable for appliances with protection class I acc. to IEC 61140
Terminal	Solder terminals 3.5 x 0.8 mm or quick connect terminals 6.3 x 0.8 mm
Panel Thickness S	Snap-in: 1/1.2/1.5/2/2.5/3mm1/1.2/1.5/2/2.5/3 mm
Material: Housing	Thermoplastic, black, UL 94V-0

appliance inlet/-outlet	C14 acc. to IEC 60320-1, F acc. to UL 498, CSA C22.2 no. 42 (for cold conditions) pin-temperature 70 °C, 10A, Protection Class I
Fuseholder	1 or 2 pole, Shocksafe category PC2 acc. to IEC 60127-6, for fuse-links 5 x 20mm
Rated Power Acceptance @ Ta 23 °C	5 x 20: 2W (1 pole)/ 1.6W (2-pole) per pole
Power Acceptance @ Ta > 23°C	Admissible power acceptance at higher ambient temperature see derating curves
Line Switch	Rocker switch 2-pole, non-illuminated, acc. to IEC 61058-1 Technical Details
Line Filter	Standard Version, IEC 60939, UL 1283, CSA C22.2 no. 8 Technical Details
MTBF	> 1'400'000h acc. to MIL-HB-217 F

Approvals and Compliances



Detailed information on product approvals, code requirements, usage instructions and detailed test conditions can be looked up in [Details about Approvals](#)

SCHURTER products are designed for use in industrial environments. They have approvals from independent testing bodies according to national and international standards. Products with specific characteristics and requirements such as required in the automotive sector according to IATF 16949, medical technology according to ISO 13485 or in the aerospace industry can be offered exclusively with customer-specific, individual agreements by SCHURTER.

Approvals









The approval mark is used by the testing authorities to certify compliance with the safety requirements placed on electronic products.

Approval Reference Type: Felcom

Approval Logo	Certificates	Certification Body	Description
	VDE Approvals	VDE	Certificate Number: 101307
	UL Approvals	UL	UL File Number: E72928



Product standards

Product standards that are referenced

Organization	Design	Standard	Description
	Designed according to	IEC 60320-1	Appliance couplers for household and similar general purposes
	Designed according to	IEC 60939	Passive filters for suppressing electromagnetic interference
	Designed according to	IEC 60127-6	Miniature fuses. Part 6. Fuse-holders for miniature fuse-links
	Designed according to	IEC 61058-1	Switches for appliances. Part 1. General requirements
	Designed according to	UL 498	Standard for Attachment Plugs and Receptacles
	Designed according to	UL 1283	Electromagnetic interference filters
	Designed according to	CSA C22.2 no. 42	General Use Receptacles, Attachment Plugs, and Similar Wiring Devices
	Designed according to	CSA C22.2 no. 8	Electromagnetic interference (EMI) filters







Application standards

Application standards where the product can be used

Organization	Design	Standard	Description
	Designed for applications acc.	IEC/UL 60950	IEC 60950-1 includes the basic requirements for the safety of information technology equipment.
	Designed for applications acc.	IEC 60601-1	Medical electrical equipment - Part 1: General requirements for basic safety and essential performance
	Designed for applications acc.	IEC 60335-1	Safety of electrical appliances for household and similar purposes. Meets the requirements for appliances in unattended use. This includes the enhanced requirements of glow wire tests acc. to IEC 60695-2-11 or -12 & -13.

Compliances

The product complies with following Guide Lines

Identification	Details	Initiator	Description
	CE declaration of conformity	SCHURTER AG	The CE marking declares that the product complies with the applicable requirements laid down in the harmonisation of Community legislation on its affixing in accordance with EU Regulation 765/2008.
	RoHS	SCHURTER AG	Directive RoHS 2011/65/EU, Amendment (EU) 2015/863
	China RoHS	SCHURTER AG	The law SJ / T 11363-2006 (China RoHS) has been in force since 1 March 2007. It is similar to the EU directive RoHS.
	REACH	SCHURTER AG	On 1 June 2007, Regulation (EC) No 1907/2006 on the Registration, Evaluation, Authorization and Restriction of Chemicals 1 (abbreviated as "REACH") entered into force.
	White paper Glow wire test	SCHURTER AG	Meets the requirements of IEC 60335-1 for appliances in unattended use. This includes the enhanced requirements of glow wire tests acc. to IEC 60695-2-11 or -12 & -13.
	Medical Technology	SCHURTER AG	Suitable for use in medical equipment according to IEC/UL 60601-1

Dimension [mm]

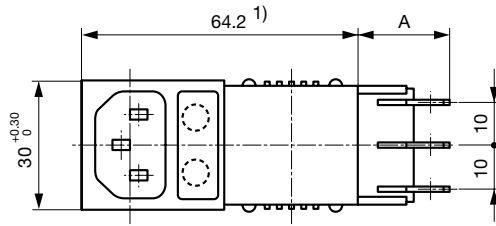

Variants 5411.XX5X.XXX
 Mounting hole: $63 +0.2 \times 27.6 +0.2$
 A: Quick-connect terminal 6.3x0.8 mm: 22 mm
 A: Solder terminal 3.5x0.8 mm: 17.5 mm
 S: Panel thickness

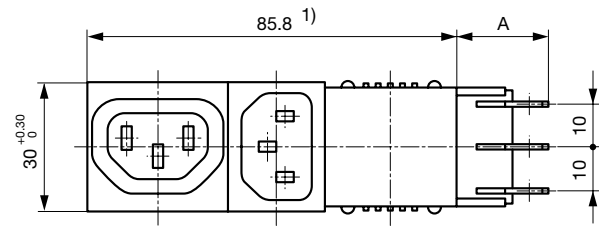

Variants 5421.X05X.XXX
 Mounting hole: $85.9+0.2 \times 27.6+0.2$
 A: Quick-connect terminal 6.3x0.8 mm: 22 mm
 A: Solder terminal 3.5x0.8 mm: 17.5 mm
 S: Panel thickness

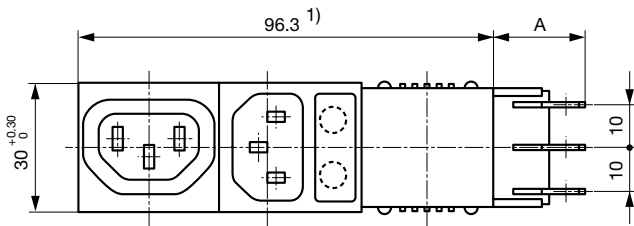

Variants 5423.XX5X.XXX
 Mounting hole: $96.4+0.2 \times 27.6+0.2$
 A: Quick-connect terminal 6.3x0.8 mm: 22 mm
 A: Solder terminal 3.5x0.8 mm: 17.5 mm
 S: Panel thickness

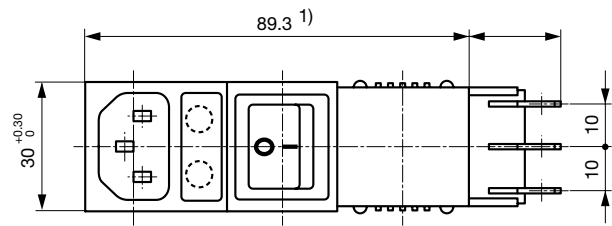

Variants 5424.XX5X.XXX
 Mounting hole: $87.9+0.2 \times 27.6+0.2$
 A: Quick-connect terminal 6.3x0.8 mm: 22 mm
 A: Solder terminal 3.5x0.8 mm: 17.5 mm
 S: Panel thickness

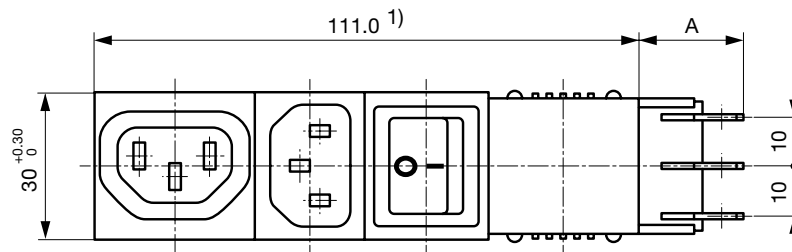

Variants 5431.X05X.XXX
 Mounting hole: $111.1+0.2 \times 27.6+0.2$
 A: Quick-connect terminal 6.3x0.8 mm: 22 mm
 A: Solder terminal 3.5x0.8 mm: 17.5 mm
 S: Panel thickness

1) In an uninstalled state the total length of the combinations may be slightly bigger than the nominal dimension. However, they can always be installed in the specified mounting cutouts.

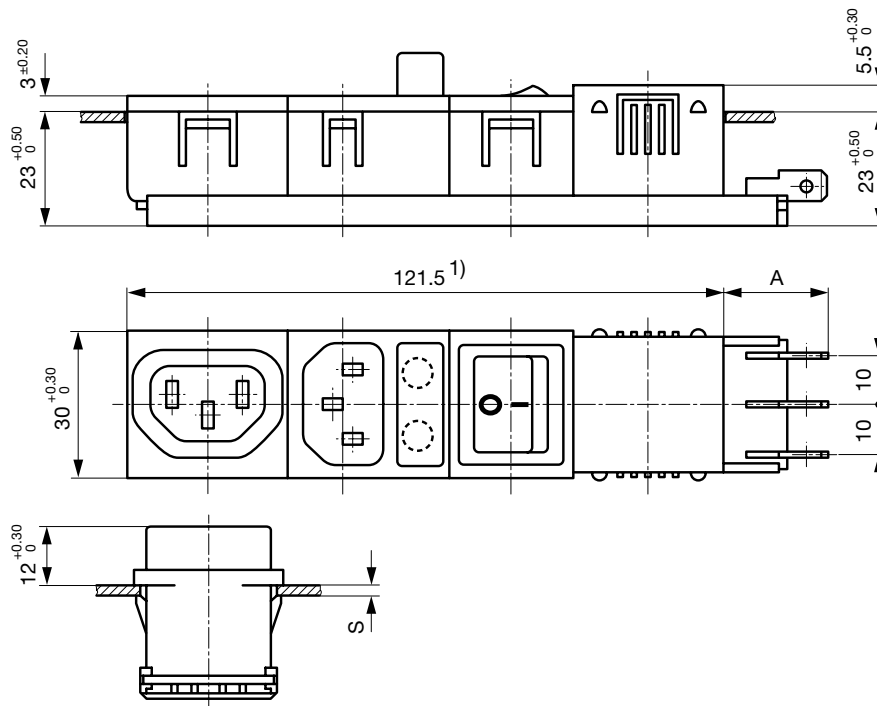

Variants 5432.XX5X.XXX

Mounting hole: 121.6+0,2 x 27.6+0,2

A: Quick-connect terminal 6.3x0.8 mm: 22 mm

A: Solder terminal 3.5x0.8 mm: 17.5 mm

S: Panel thickness

1) In an uninstalled state the total length of the combinations may be slightly bigger than the nominal dimension. However, they can always be installed in the specified mounting cutouts.

Technical Data of Filter-Components

Rated Current [A]	Filter-Type	Inductances L [mH]	Capacitance CX [nF]	Capacitance CY [nF]	R [MΩ]
1	Standard Version	2 x 11	47	2.2	-
2	Standard Version	2 x 4	47	2.2	-
4	Standard Version	2 x 1.6	47	2.2	-
6	Standard Version	2 x 0.7	47	2.2	-
8	Standard Version	2 x 0.6	47	2.2	-
10	Standard Version	2 x 0.4	47	2.2	-
1	Medical Version (M5)	2 x 11	47	-	1
2	Medical Version (M5)	2 x 4	47	-	1
4	Medical Version (M5)	2 x 1.6	47	-	1
6	Medical Version (M5)	2 x 0.7	47	-	1
8	Medical Version (M5)	2 x 0.6	47	-	1
10	Medical Version (M5)	2 x 0.4	47	-	1

Diagrams

5411

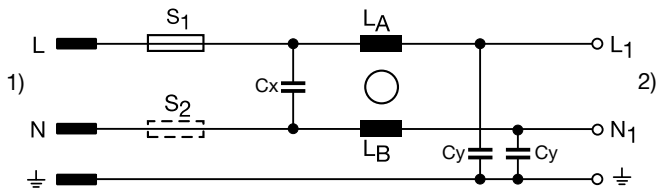

1) Line
 2) Load 1

5423

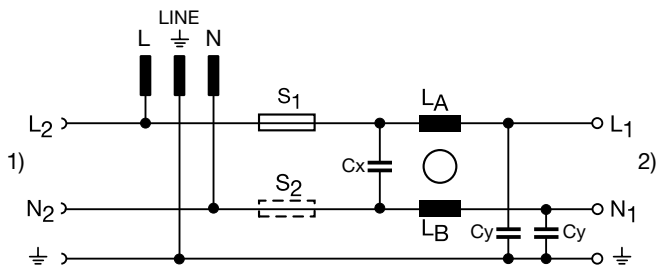

1) Load 2
 2) Load 1

5431

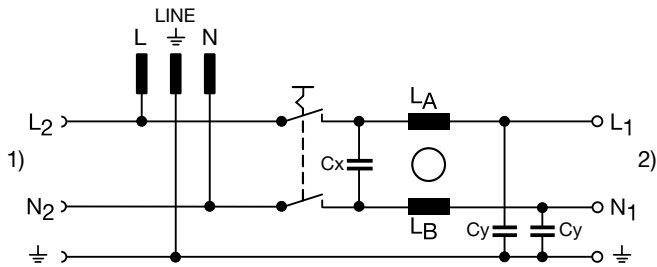

1) Load 2
 2) Load 1

5421

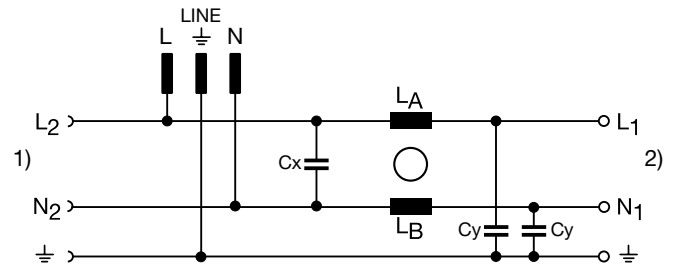

1) Load 2
 2) Load 1

5424

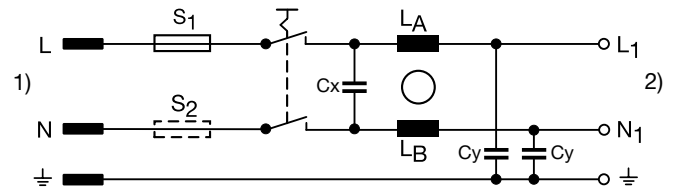

1) Line
 2) Load 1

5432

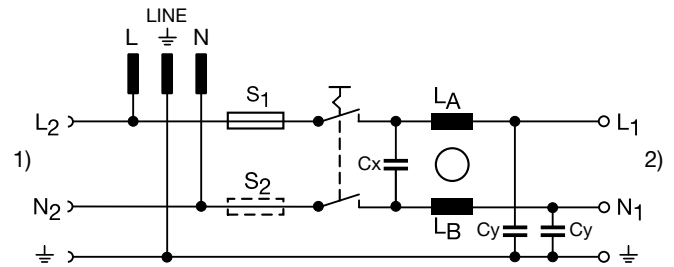

1) Load 2
 2) Load 1

Derating Curves

1-pole

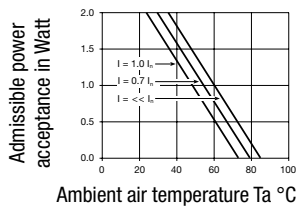

2-pole

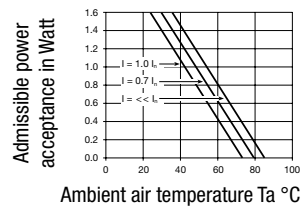

All Variants

Type	Rated Current [A]	Filter-Type	Panel Thickness [mm]	connection type	Line Switch	Fuseholder	Connectors	Connector	Order Number
Felcom 54	1	Standard Version	1.5	Solder terminals 3.5 x 0.8 mm	-	1-pole	C14	-	5411.1151.151
Felcom 54	1	Standard Version	2.5	Solder terminals 3.5 x 0.8 mm	-	1-pole	C14	-	5411.1151.251
Felcom 54	1	Standard Version	1.5	Quick connect terminals 6.3 x 0.8 mm	-	2-pole	C14	-	5411.1253.151
Felcom 54	1	Standard Version	2.0	Quick connect terminals 6.3 x 0.8 mm	-	-	C14	F	5421.1053.201
Felcom 54	1	Standard Version	1.5	Solder terminals 3.5 x 0.8 mm	2-pole	1-pole	C14	-	5424.1151.151
Felcom 54	1	Standard Version	2.0	Solder terminals 3.5 x 0.8 mm	2-pole	1-pole	C14	-	5424.1151.201
Felcom 54	1	Standard Version	3.0	Solder terminals 3.5 x 0.8 mm	2-pole	1-pole	C14	-	5424.1151.301
Felcom 54	1	Standard Version	2.0	Quick connect terminals 6.3 x 0.8 mm	2-pole	1-pole	C14	-	5424.1153.201
Felcom 54	1	Standard Version	3.0	Quick connect terminals 6.3 x 0.8 mm	2-pole	1-pole	C14	-	5424.1153.301
Felcom 54	1	Standard Version	1.0	Quick connect terminals 6.3 x 0.8 mm	2-pole	2-pole	C14	-	5424.1253.101
Felcom 54	1	Standard Version	1.5	Quick connect terminals 6.3 x 0.8 mm	2-pole	2-pole	C14	-	5424.1253.151
Felcom 54	1	Standard Version	2.0	Quick connect terminals 6.3 x 0.8 mm	2-pole	2-pole	C14	-	5424.1253.201
Felcom 54	1	Standard Version	3.0	Quick connect terminals 6.3 x 0.8 mm	2-pole	2-pole	C14	-	5424.1253.301
Felcom 54	1	Standard Version	2.5	Quick connect terminals 6.3 x 0.8 mm	2-pole	1-pole	C14	F	5432.1153.251
Felcom 54	1	Standard Version	2.0	Quick connect terminals 6.3 x 0.8 mm	2-pole	2-pole	C14	F	5432.1253.201
Felcom 54	1	Medical Version (M5)	2.0	Solder terminals 3.5 x 0.8 mm	-	2-pole	C14	-	5411.1251.203
Felcom 54	1	Medical Version (M5)	2.0	Solder terminals 3.5 x 0.8 mm	2-pole	2-pole	C14	-	5424.1251.203
Felcom 54	1	Medical Version (M5)	1.5	Quick connect terminals 6.3 x 0.8 mm	2-pole	2-pole	C14	-	5424.1253.153
Felcom 54	1	Medical Version (M5)	3.0	Quick connect terminals 6.3 x 0.8 mm	2-pole	2-pole	C14	-	5424.1253.303
Felcom 54	2	Standard Version	1.2	Solder terminals 3.5 x 0.8 mm	-	1-pole	C14	-	5411.2151.121
Felcom 54	2	Standard Version	2.0	Solder terminals 3.5 x 0.8 mm	-	-	C14	F	5421.2051.201
Felcom 54	2	Standard Version	1.5	Solder terminals 3.5 x 0.8 mm	2-pole	1-pole	C14	-	5424.2151.151
Felcom 54	2	Standard Version	2.5	Solder terminals 3.5 x 0.8 mm	2-pole	1-pole	C14	-	5424.2151.251
Felcom 54	2	Standard Version	1.0	Quick connect terminals 6.3 x 0.8 mm	2-pole	1-pole	C14	-	5424.2153.101
Felcom 54	2	Standard Version	1.2	Quick connect terminals 6.3 x 0.8 mm	2-pole	2-pole	C14	-	5424.2253.121
Felcom 54	2	Standard Version	2.0	Quick connect terminals 6.3 x 0.8 mm	2-pole	2-pole	C14	-	5424.2253.201
Felcom 54	2	Standard Version	3.0	Quick connect terminals 6.3 x 0.8 mm	2-pole	2-pole	C14	-	5424.2253.301
Felcom 54	2	Standard Version	1.0	Quick connect terminals 6.3 x 0.8 mm	2-pole	-	C14	F	5431.2053.101
Felcom 54	2	Standard Version	1.5	Quick connect terminals 6.3 x 0.8 mm	2-pole	1-pole	C14	F	5432.2153.151
Felcom 54	2	Standard Version	1.2	Quick connect terminals 6.3 x 0.8 mm	2-pole	2-pole	C14	F	5432.2253.121
Felcom 54	2	Standard Version	2.0	Quick connect terminals 6.3 x 0.8 mm	2-pole	2-pole	C14	F	5432.2253.201
Felcom 54	2	Standard Version	2.5	Quick connect terminals 6.3 x 0.8 mm	2-pole	2-pole	C14	F	5432.2253.251
Felcom 54	2	Medical Version (M5)	1.2	Quick connect terminals 6.3 x 0.8 mm	-	2-pole	C14	-	5411.2253.123
Felcom 54	2	Medical Version (M5)	2.0	Solder terminals 3.5 x 0.8 mm	2-pole	2-pole	C14	-	5424.2251.203
Felcom 54	2	Medical Version (M5)	1.5	Quick connect terminals 6.3 x 0.8 mm	2-pole	2-pole	C14	-	5424.2253.153
Felcom 54	2	Medical Version (M5)	2.0	Quick connect terminals 6.3 x 0.8 mm	2-pole	2-pole	C14	-	5424.2253.203
Felcom 54	4	Standard Version	1.5	Quick connect terminals 6.3 x 0.8 mm	-	2-pole	C14	-	5411.4253.151
Felcom 54	4	Standard Version	2.5	Quick connect terminals 6.3 x 0.8 mm	-	2-pole	C14	-	5411.4253.251
Felcom 54	4	Standard Version	1.5	Quick connect terminals 6.3 x 0.8 mm	-	-	C14	F	5421.4053.151
Felcom 54	4	Standard Version	1.5	Quick connect terminals 6.3 x 0.8 mm	-	2-pole	C14	F	5423.4253.151
Felcom 54	4	Standard Version	1.5	Quick connect terminals 6.3 x 0.8 mm	2-pole	1-pole	C14	-	5424.4153.151
Felcom 54	4	Standard Version	1.0	Quick connect terminals 6.3 x 0.8 mm	2-pole	2-pole	C14	-	5424.4253.101

Type	Rated Current [A]	Filter-Type	Panel Thickness [mm]	connection type	Line Switch	Fuseholder	Connectors	Connector	Order Number
Felcom 54	4	Standard Version	1.5	Quick connect terminals 6.3 x 0.8 mm	2-pole	2-pole	C14	-	5424.4253.151
Felcom 54	4	Standard Version	2.0	Quick connect terminals 6.3 x 0.8 mm	2-pole	2-pole	C14	-	5424.4253.201
Felcom 54	4	Standard Version	2.5	Quick connect terminals 6.3 x 0.8 mm	2-pole	2-pole	C14	-	5424.4253.251
Felcom 54	4	Standard Version	2.5	Quick connect terminals 6.3 x 0.8 mm	2-pole	1-pole	C14	F	5432.4153.251
Felcom 54	4	Standard Version	2.0	Solder terminals 3.5 x 0.8 mm	2-pole	2-pole	C14	F	5432.4251.201
Felcom 54	4	Standard Version	1.5	Quick connect terminals 6.3 x 0.8 mm	2-pole	2-pole	C14	F	5432.4253.151
Felcom 54	4	Standard Version	2.0	Quick connect terminals 6.3 x 0.8 mm	2-pole	2-pole	C14	F	5432.4253.201
Felcom 54	4	Medical Version (M5)	1.0	Quick connect terminals 6.3 x 0.8 mm	-	2-pole	C14	-	5411.4253.103
Felcom 54	4	Medical Version (M5)	1.0	Quick connect terminals 6.3 x 0.8 mm	2-pole	2-pole	C14	-	5424.4253.103
Felcom 54	4	Medical Version (M5)	1.5	Quick connect terminals 6.3 x 0.8 mm	2-pole	2-pole	C14	-	5424.4253.153
Felcom 54	4	Medical Version (M5)	2.0	Quick connect terminals 6.3 x 0.8 mm	2-pole	2-pole	C14	-	5424.4253.203
Felcom 54	4	Medical Version (M5)	3.0	Quick connect terminals 6.3 x 0.8 mm	2-pole	2-pole	C14	-	5424.4253.303
Felcom 54	6	Standard Version	1.5	Quick connect terminals 6.3 x 0.8 mm	-	2-pole	C14	-	5411.6253.151
Felcom 54	6	Standard Version	2.0	Quick connect terminals 6.3 x 0.8 mm	-	2-pole	C14	-	5411.6253.201
Felcom 54	6	Standard Version	1.5	Quick connect terminals 6.3 x 0.8 mm	-	2-pole	C14	F	5423.6253.151
Felcom 54	6	Standard Version	2.0	Quick connect terminals 6.3 x 0.8 mm	-	2-pole	C14	F	5423.6253.201
Felcom 54	6	Standard Version	3.0	Quick connect terminals 6.3 x 0.8 mm	-	2-pole	C14	F	5423.6253.301
Felcom 54	6	Standard Version	1.5	Solder terminals 3.5 x 0.8 mm	2-pole	1-pole	C14	-	5424.6151.151
Felcom 54	6	Standard Version	1.2	Quick connect terminals 6.3 x 0.8 mm	2-pole	1-pole	C14	-	5424.6153.121
Felcom 54	6	Standard Version	1.5	Quick connect terminals 6.3 x 0.8 mm	2-pole	1-pole	C14	-	5424.6153.151
Felcom 54	6	Standard Version	1.0	Quick connect terminals 6.3 x 0.8 mm	2-pole	2-pole	C14	-	5424.6253.101
Felcom 54	6	Standard Version	1.5	Quick connect terminals 6.3 x 0.8 mm	2-pole	2-pole	C14	-	5424.6253.151
Felcom 54	6	Standard Version	2.0	Quick connect terminals 6.3 x 0.8 mm	2-pole	2-pole	C14	-	5424.6253.201
Felcom 54	6	Standard Version	2.5	Quick connect terminals 6.3 x 0.8 mm	2-pole	2-pole	C14	-	5424.6253.251
Felcom 54	6	Standard Version	3.0	Quick connect terminals 6.3 x 0.8 mm	2-pole	2-pole	C14	-	5424.6253.301
Felcom 54	6	Standard Version	2.0	Solder terminals 3.5 x 0.8 mm	2-pole	2-pole	C14	F	5432.6251.201
Felcom 54	6	Standard Version	1.0	Quick connect terminals 6.3 x 0.8 mm	2-pole	2-pole	C14	F	5432.6253.101
Felcom 54	6	Standard Version	1.5	Quick connect terminals 6.3 x 0.8 mm	2-pole	2-pole	C14	F	5432.6253.151
Felcom 54	6	Standard Version	3.0	Quick connect terminals 6.3 x 0.8 mm	2-pole	2-pole	C14	F	5432.6253.301
Felcom 54	6	Medical Version (M5)	2.5	Quick connect terminals 6.3 x 0.8 mm	-	2-pole	C14	-	5411.6253.253
Felcom 54	8	Standard Version	1.2	Quick connect terminals 6.3 x 0.8 mm	-	2-pole	C14	-	5411.6253.121

Availability for all products can be searched real-time: <https://www.schurter.com/en/Stock-Check/Stock-Check-SCHURTER>

Packaging unit 10 Pcs

Accessories

Description



Cord retaining kits
 Cord retaining strain relief

Flat head, A

4700.0001

Mating Inlets/Plugs

Category / Description

[Plug Overview complete](#)



4732, Mounting: Power Cord, Plug: IEC E, Cable	4732
4735, Mounting: Power Cord, Plug: IEC E, Cable	4735
9009, Mounting: Plug: IEC E, Screw clamps	9009
4733, Mounting: Power Cord, Plug: IEC E, Cable	4733
4736, Mounting: Power Cord, Plug: IEC E, Cable	4736
Plug further types to Felcom 54	...

Mating Outlets/Connectors

[Appliance Outlet Overview complete](#)



4787, Mounting: Screw-on mounting, Appliance Outlet: IEC Solder terminals, 10 A, Suitable for appliances with protection class I	4787
4788, Mounting: Snap-in version, Appliance Outlet: IEC Solder terminals or quick connect terminals, 10 A, Suitable for appliances with protection class I	4788
IEC Appliance Outlet F or H, Screw-on Mounting, Front Side, Solder, PCB or Quick-connect Terminal	5091
Appliance Outlet further types to Felcom 54	...

[Connector Overview complete](#)



4022 Mounting: Power Supply Cord, 3 x 1.5 mm ² , Screw clamps, Connector: IEC C13	4022
4782 Mounting: Power Cord, 3 x 1 mm ² / 3 x 18 AWG, Cable, Connector: IEC C13	4782
4012 Mounting: Power Supply Cord, 3 x 1 mm ² , Screw clamps, Connector: IEC C13	4012
4785 Mounting: Power Cord, 3 x 1 mm ² / 3 x 18 AWG, Cable, Connector: IEC C13	4785
4300-06 Mounting: Power Cord, 3 x 1 mm ² / 3 x 18 AWG, Cable, Connector: IEC C13	4300-06
Connector further types to Felcom 54	...