

IEC Appliance Outlet F, Screw-on Mounting, Rear Side, PCB-/Solder Terminal

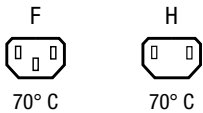

See below:
[Approvals and Compliances](#)

Description

- Panel mount :
 Screw-on mounting from rear-side
- 1 Function
- Connector , Pin temperature 70 °C , protection class I or II
- For PCB mounting

Other versions on request

- For protection class II

References

Substitute for type [P675/PC](#)
 Alternative: protection class II version

Weblinks

[pdf data sheet](#), [html datasheet](#), [General Product Information](#), [Distributor-Stock-Check](#), [Accessories](#), [Detailed request for product](#)

Technical Data

| | | | |
|---------------------------------|---|-------------------------|--|
| Ratings IEC | 10A / 250VAC; 50Hz | appliance inlet/-outlet | F acc. to IEC 60320-3 |
| Ratings UL/CSA | 15A / 250VAC; 60Hz | | UL 60320-1, CSA C22.2 no. 60320-1 |
| Dielectric Strength | > 4 kVAC between L-N > 2 kVAC between L/N-PE (1 min/50Hz) | | (for cold conditions) pin-temperature 70 °C, 10A, Protection Class I or II |
| Allowable Operation Temperature | -25 °C to 70 °C | | |
| IP-Protection | from front side IP20 acc. to IEC 60529 | | |
| Insulation cover | Suitable for appliances with protection class I or II acc. to IEC 61140 | | |
| Terminal | For PCB mounting : Ground terminal: Solder terminal straight | | |
| Material: Housing | PA6, black, UL 94V-0 | | |

Approvals and Compliances

Detailed information on product approvals, code requirements, usage instructions and detailed test conditions can be looked up in [Details about Approvals](#)

SCHURTER products are designed for use in industrial environments. They have approvals from independent testing bodies according to national and international standards. Products with specific characteristics and requirements such as required in the automotive sector according to IATF 16949, medical technology according to ISO 13485 or in the aerospace industry can be offered exclusively with customer-specific, individual agreements by SCHURTER.

Approvals





The approval mark is used by the testing authorities to certify compliance with the safety requirements placed on electronic products.

Approval Reference Type: 5001

| Approval Logo | Certificates | Certification Body | Description |
|---------------|--------------------------------|--------------------|---|
| | KEMA Approvals | KEMA | Certificate Number: 71-104273, 71-104274 (PC I & PC II @ KEMA) |
| | UL Approvals | UL | UL File Number: E103791 |
| | CCC Approvals | CCC | CCC Certificate Number: 2015180204000595 (PC I only / nur SK I) |

Product standards

Product standards that are referenced

| Organization | Design | Standard | Description |
|--|-----------------------|-----------------------|---|
|  | Designed according to | IEC 60320-1 | Appliance couplers for household and similar general purposes |
|  | Designed according to | IEC 60320-3 | Appliance couplers for household and similar general purposes |
|  | Designed according to | UL 60320-1 | Standard for Attachment Plugs and Receptacles |
|  | Designed according to | CSA C22.2 no. 60320-1 | General Use Receptacles, Attachment Plugs, and Similar Wiring Devices |





Application standards

Application standards where the product can be used

| Organization | Design | Standard | Description |
|--|--------------------------------|--------------|---|
|  | Designed for applications acc. | IEC/UL 60950 | IEC 60950-1 includes the basic requirements for the safety of information technology equipment. |

Compliances

The product complies with following Guide Lines

| Identification | Details | Initiator | Description |
|--|--|-------------|---|
|  | CE declaration of conformity | SCHURTER AG | The CE marking declares that the product complies with the applicable requirements laid down in the harmonisation of Community legislation on its affixing in accordance with EU Regulation 765/2008. |
|  | RoHS | SCHURTER AG | Directive RoHS 2011/65/EU, Amendment (EU) 2015/836 |
|  | China RoHS | SCHURTER AG | The law SJ / T 11363-2006 (China RoHS) has been in force since 1 March 2007. It is similar to the EU directive RoHS. |
|  | REACH | SCHURTER AG | On 1 June 2007, Regulation (EC) No 1907/2006 on the Registration, Evaluation, Authorization and Restriction of Chemicals 1 (abbreviated as "REACH") entered into force. |

Dimensions [mm]

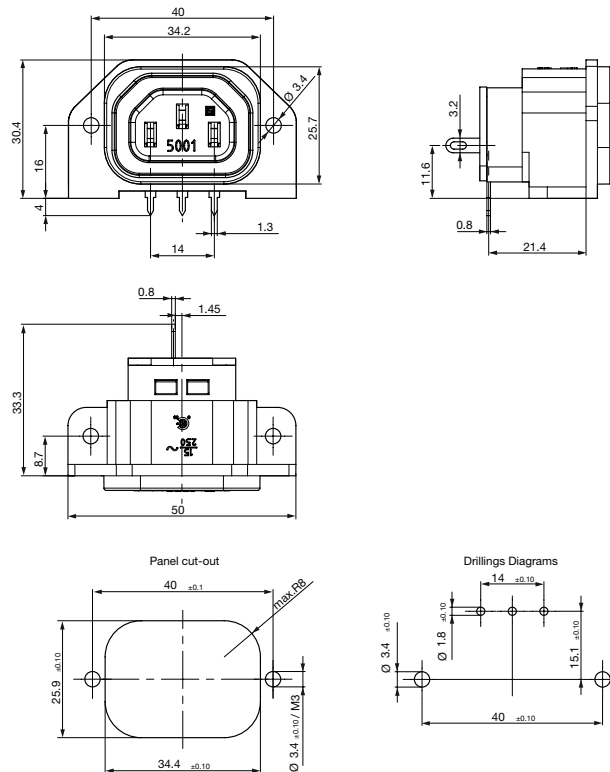

Config. Code

5001 - H - A B C 0 - D - E

The characters are placeholders for the correspondingly keys of selections from the key tables.

5001 - H - A B C 0 - D - E = Type

| Type | Configuration key |
|---------------------|-------------------|
| protection class II | B |
| protection class I | X |

5001 - H - A B C 0 - D - E = Terminals

| Terminal L | Configuration key |
|---|-------------------|
| PCB-terminal standard  | 4 |

5001 - H - A B C 0 - D - E = Terminals

| Terminal N | Configuration key |
|-----------------------|-------------------|
| PCB-terminal standard | 4 |

Symbols similar as in table A

5001 - H - A B C 0 - D - E = Terminals

| Terminal Ground | Configuration key |
|--|-------------------|
| without terminal | 0 |
| PCB-terminal long (additional solder terminal) | 6 |

Symbols similar as in table A

5001 - H - A B C 0 - D - E = Color

| Color | Configuration key |
|-------|-------------------|
| Black | A |

5001 - H - A B C 0 - D - E = Style

| Style | Configuration key |
|---------------------------|-------------------|
| flange with through holes | 2 |

All Variants

| Type | Terminals L / N | Terminal Ground | Color | Style | Features | Config. Code | Order Number |
|--------------------|-------------------------|--|-------|---------------------------|----------|-----------------|--------------|
| Protection class I | PCB-terminal (standard) | PCB-terminal long (additional solder terminal) | black | Flange with through holes | - | 5001-X-4460-A-2 | 6182.0033 |

The listed variants should be available from stock. Other versions on request www.schurter.com/contact

Most Popular.

Availability for all products can be searched real-time: <https://www.schurter.com/en/Stock-Check/Stock-Check-SCHURTER>

Packaging unit 50 Pcs

Mating Inlets/Plugs

Category / Description

[Plug Overview complete](#)



| | |
|--|------|
| 4732, Mounting: Power Cord, Plug: IEC E, Cable | 4732 |
| 4735, Mounting: Power Cord, Plug: IEC E, Cable | 4735 |
| 9009, Mounting: Plug: IEC E, Screw clamps | 9009 |
| 4733, Mounting: Power Cord, Plug: IEC E, Cable | 4733 |
| 4736, Mounting: Power Cord, Plug: IEC E, Cable | 4736 |
| Plug further types to 5001 | ... |